

LETO 11

SUSPENDED UP/DOWN LED CYLINDER

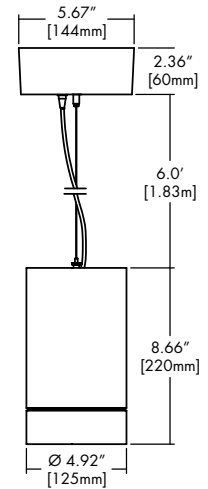

Features

- Faceted and Smooth metal reflectors provide beam spreads between 10° to 80°.
- Nine drivers selections available to cover wide range of applications.
- Three output options available up to 1500 lumens.
- Five year warranty.

Finish Options

- White
- Mocha
- Black
- Charcoal
- Silver
- Cerulean
- Firebrick



Technical Information

OUTPUT OPTIONS		700 lm	1000 lm	1500 lm
DOWN	Fixture wattage	6.1 W	9.1 W	14.0 W
	Delivered Lumen at 3500K	656 lm	1035 lm	1539 lm
	Efficacy	108 lm/W	114 lm/W	110 lm/W
	Center Beam Candlepower (10° Faceted Reflector)	5474 cd	8637 cd	12842 cd
UP	Fixture wattage	6.1 W	9.1 W	
	Delivered Lumen at 3500K	614 lm	857 lm	
	Efficacy	101 lm/W	94 lm/W	

CCT	Multiplier	CRI	TM-30		
			R _f	R _g	R ₉
2500K	0.81	92	90	104	77
2700K	0.92	92	91	102	61
3000K	0.97	95	92	102	61
3500K	1.00	95	93	101	72
4000K	1.07	95	92	103	68
6500K	1.05	96	91	100	89

Integral Driver Example: Fixture LET11-S-0707-25K-F10-F17-NA-WH-WH-RD-WH-2AF-NA-PHSD-NA
 Remote Driver Example: Fixture LET11-S-0707-25K-F10-F17-NA-WH-WH-RD-WH-2AF-NA-010L-NA
 HRM-LET11-S-0707-25K-010L-NA

Ordering Code

MODEL	TYPE	OUTPUT	CCT	OPTIC	OPTIC UP	ACCESSORY ⁸	BODY FINISH	BAFFLE FINISH
LET11-Leto 11	S-Suspended	0707-700 lumens down, 700 lumens up 1010-1000 lumens down, 1000 lumens up 1515-1500 lumens down, 1000 lumens up	25K-2500K 27K-2700K 30K-3000K 35K-3500K 40K-4000K 65K-6500K	F10-10 Degree, Faceted F18-18 Degree, Faceted F30-30 Degree, Faceted F45-45 Degree, Faceted F60-60 Degree, Faceted S30-30 Degree, Smooth S45-45 Degree, Smooth S80-80 Degree, Smooth	F17-17 Degree, Faceted F24-24 Degree, Faceted F60-60 Degree, Faceted	NA-No Accessory CL-Clear Lens DL-Diffusing Lens HC-Honeycomb Louver SL-Solite Lens	Standard WH-White BK-Black SL-Silver Premium ¹ MA-Mocha CC-Charcoal CR-Cerulean FB-Firebrick	Standard WH-White BK-Black SL-Silver Premium ¹ MA-Mocha CC-Charcoal CR-Cerulean FB-Firebrick
CANOPY/ HOUSING	CANOPY FINISH	SUSPENSION TYPE	SUSPENSION FINISH	DRIVER		DRIVER OPTIONS		
RD - Round RTL - Round Trimless ^{2,5} SQ - Square	Standard WH - White BK - Black SL - Silver Premium ¹ MA - Mocha CC - Charcoal CR - Cerulean FB - Firebrick	2AF - 2AC+Feed Cable POA - 2 Powered Aircraft	Standard NA - None ³ CL - Clear ¹⁰ WH - White BK - Black	PHSD - Forward/Reverse Phase, 1% Dimming, 120V Only 0105-0-10V, 1% Dimming, 120V/277V 0103-0-10V, 1% Dimming, 347V Only 010L-EldoLED, 0-10V, Linear, 0.1% Dimming, 120V/277V ⁴ 010G-EldoLED, 0-10V, Log, 0.1% Dimming, 120V/277V ⁴ DALI-EldoLED, DALI Protocol 2, DT-6, 0.1% Dimming, 120V/277V DALI8-EldoLED, DALI Protocol 2, DT-8, 0.1% Dimming, 120V/277V ² LUTE-Lutron Hilume Ecodigital, 1% Dimming, 120V/277V DMX-EldoLED, DMX, 0.1% Dimming, 120V/277V ²		NA - None EMG - Emergency Driver ^{2,6} CSMB - Casambi ^{7,8} AWN - Athena ^{7,8}		

1 - Premium finishes may have extended lead times. Custom RALs are available, please consult Inside Sales with specific request.
 2 - All drivers remote mounted when using RTL canopy, DALI8 driver, DMX driver, or EMG driver options.
 3 - Must select NA None when POA option is selected.
 4 - Requires square canopy SQ for integral driver, otherwise remote mounted.
 5 - RTL canopy is not available with HS2/HS3/HS6 suspension.
 6 - Emergency option comes prewired from factory with driver in remote housing. 8W of continuous power provided for a minimum of 90 minutes. Must be installed within 30 feet of luminaire using 18 AWG wire. Not available with 0103, DMX, DALI8 or LUTE Driver.
 7 - AWNR/CSMB only available with 010S driver and RD/SQ canopy
 8 - AWNR/CSMB available upon request with RTL canopy.
 9 - Accessory only installed in bottom light.
 10 - Clear Suspension Finish only available with 2AF.
 CONTACT FACTORY FOR MORE OPTIONS.

Canopy

RD Round Canopy

	Integral Drivers	Remote Drivers
 <p>2.36" 60mm</p> <p>Ø5.17" 131mm</p>	010S	010L
	0103	010G
	PHSD	DAI
		DAI8
		LUTE
		DMX

RTL Round Trimless Canopy

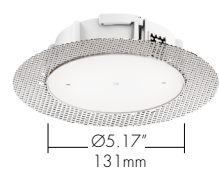
	Integral Drivers	Remote Drivers
 <p>Ø5.17" 131mm</p>	N/A	010S
		0103
		PHSD
		010L
		010G
		DAI
		DAI8
		LUTE
		DMX

SQ Square Canopy

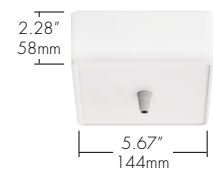
	Integral Drivers	Remote Drivers
 <p>2.28" 58mm</p> <p>5.67" 144mm</p>	010S	DMX
	0103	DAI8
	PHSD	
	010L	
	010G	
	DAI	
	DAI8	
	LUTE	

Please see next page for Remote Driver Housing details.

Suspension

2AF 2 Aircraft + Feed Cable



POA 2 Powered Aircraft



Lens & Accessory Options

OPTC-ACC-CL-94MM

Clear Lens
Also available with complete fixture, use ordering code.
-CL



Light Loss Factor: 100%*

OPTC-ACC-DL-94MM

Diffusing Lens
Also available with complete fixture, use ordering code.
-DL



Light Loss Factor: 87%*

OPTC-ACC-HC-94MM

Honeycomb Lens
Also available with complete fixture, use ordering code.
-HC



Light Loss Factor: 45%*

OPTC-ACC-SL-94MM

Solite Lens
Also available with complete fixture, use ordering code.
-SL



Light Loss Factor: 92%*

*Light Loss Factor calculated with 60° faceted reflector.

Optics

RFLC-FXX-94MM

Faceted Reflector
Also available with complete fixture, use ordering code.
-F10/-F18/-F30/-F45/-F60



RFLC-SXX-94MM

Smooth Reflector
Also available with complete fixture, use ordering code.
-S30/-S45/-S60



FXX	Optic
F10	10° Faceted
F18	18° Faceted
F30	30° Faceted
F45	45° Faceted
F60	60° Faceted
S30	30° Smooth
S45	45° Smooth
S80	80° Smooth

Remote Driver Housing

Depending on the options selected in the order code on page 1, a Remote Driver Housing may be required. This will automatically be generated and put on your order as necessary.

REMOTE DRIVER	MODEL	OUTPUT	CCT	DRIVER	DRIVER OPTIONS
HRM-Housing, Remote	LET11-S-letto 11 Suspended	Same as Fixture	Same as Fixture	Same as Fixture	Same as Fixture

Maximum mounting distance to luminaire using 18 AWG wire						
010S	PHSD	010L	010G	DALI DALI8	DMX	LUTE
16'	16'	72'	72'	72'	149'	15'

HRM Single with Externally Mounted Driver

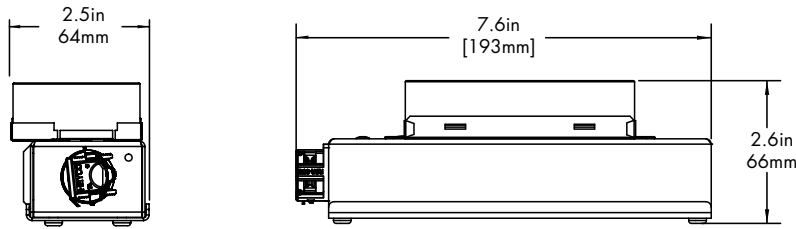

Canopy	+	Driver
RTL or RD	+	010L or 010G
RTL or RD	+	010S
RTL	+	010L or 010G or 010S
RTL or RD	+	DALI or LUTE

HRM Single

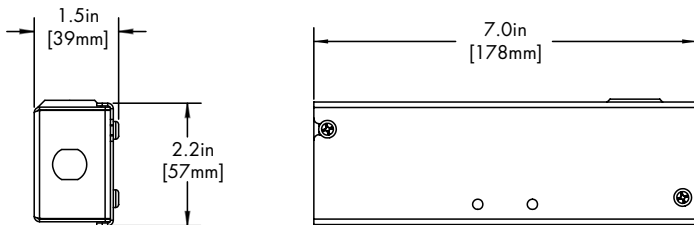

Canopy	+	Driver
RTL	+	PHSD

HRM Double

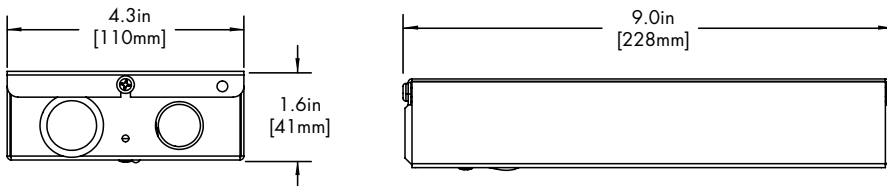

Driver
DALI8
DMX

EMG Emergency Driver

120 minute EMG operation time.

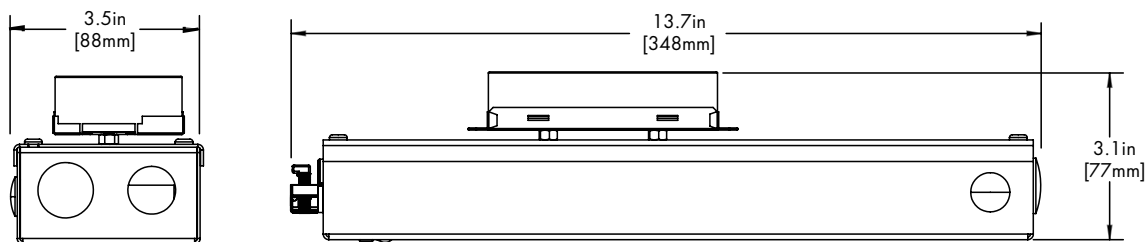

Driver
EMG

Standard Finishes

BK
Black



WH
White



SL
Silver



Premium Finishes

MA
Mocha



CC
Charcoal



CR
Cerulean

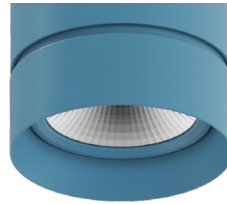

FB
Firebrick

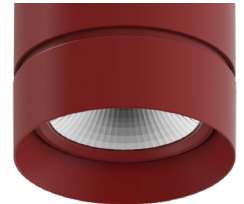

Two Tone Baffle

Inside finish refers to Baffle Finish selection from page 1. Any combination may be used for baffle and body finishes.

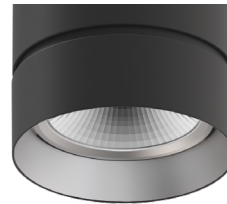
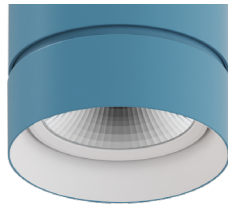
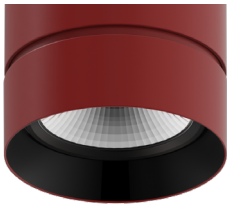

TM-30

2500K

COLOR VECTOR GRAPHIC

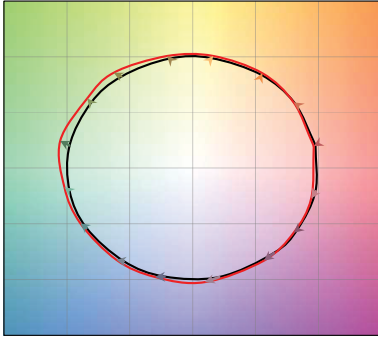

— Reference Source — Test Source

2700K

COLOR VECTOR GRAPHIC

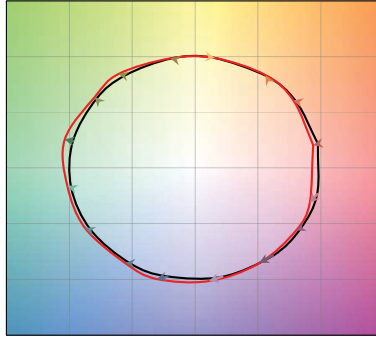

— Reference Source — Test Source

3000K

COLOR VECTOR GRAPHIC

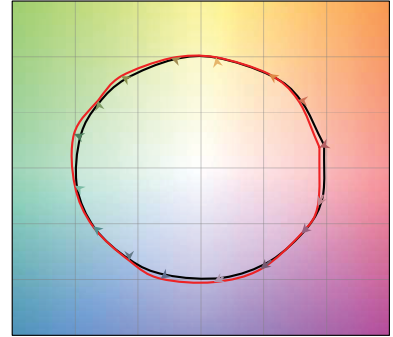

— Reference Source — Test Source

3500K

COLOR VECTOR GRAPHIC



— Reference Source — Test Source

4000K

COLOR VECTOR GRAPHIC



— Reference Source — Test Source

6500K

COLOR VECTOR GRAPHIC

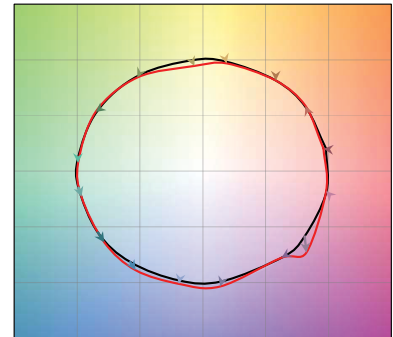

— Reference Source — Test Source

Photometry

LET11-S-0707-35K-F10-F17-NA

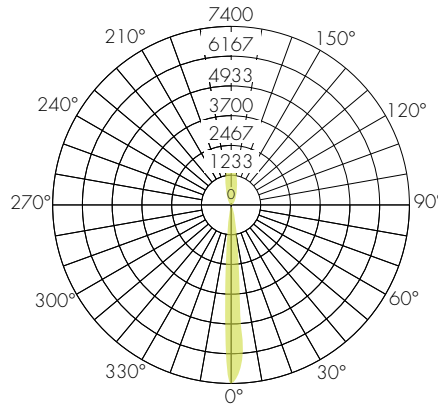
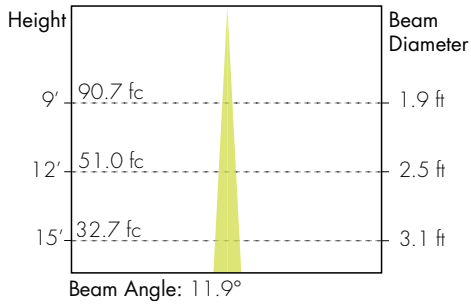

LET11-S-1010-35K-F10-F17-NA

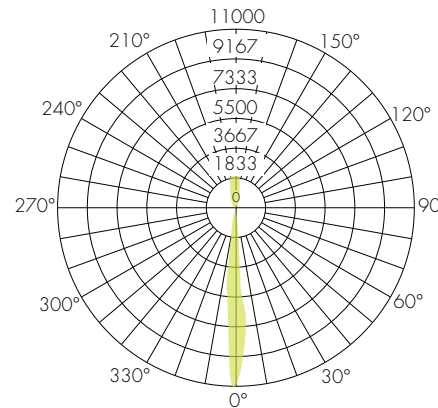
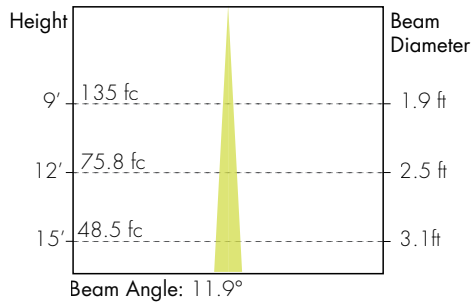

LET11-S-1515-35K-F10-F17-NA

