

# LETO 11.5

SURFACE CONDUIT LED CYLINDER  
TUNABLE WHITE & WARM DIM



## Features

- Faceted and Smooth metal reflectors provide beam spreads between 10° to 80°.
- Nine drivers selections available to cover wide range of applications.
- Three output options available up to 1500 lumens.
- 5 year warranty.



## Finish Options

- White
- Mocha
- Black
- Charcoal
- Silver
- Cerulean
- Firebrick



## Technical Information

TYPE	WD1830			TW2765
	<b>OUTPUT OPTIONS</b>	700 lm	1000 lm	1500 lm
<b>Fixture wattage</b>	7.6 W	11.2 W	16.2 W	16.4 W
<b>Delivered Lumen at full on</b>	713 lm	1072 lm	1563 lm	1500 lm
<b>Efficacy</b>	94 lm/W	96 lm/W	96 lm/W	91 lm/W
<b>Center Beam Candlepower (10° Faceted Reflector)</b>	5950 cd	8945 cd	13042 cd	12517 cd

CCT	CRI	TM-30		
		R <sub>f</sub>	R <sub>g</sub>	R <sub>9</sub>
1800K	94	90	93	61
3000K	94	89	97	72
2700K	91	90	96	59
6500K	93	87	97	73

Integral Driver Example: Fixture LET115-C-07-WD1830-F10-NA-WH-WH-PHSD-NA

Remote Driver Example: Fixture LET115-SC-07-WD1830-F10-NA-WH-WH-010L-NA

HRM-LET115-C-07-WD1830-010L-NA

## Ordering Code

### Fixture

MODEL	TYPE	OUTPUT	CCT	OPTIC	ACCESSORY	BODY FINISH	BAFFLE FINISH
LET115-Leto 11.5	SC-Surface Conduit	07-700 lumens 10-1000 lumens 15-1500 lumens	WD1830-Warm Dim, 1800K-3000K TW2765-Tunable White, 2700K-6500K <sup>3</sup>	F10-10 Degree, Faceted F18-18 Degree, Faceted F30-30 Degree, Faceted F45-45 Degree, Faceted F60-60 Degree, Faceted S30-30 Degree, Smooth S45-45 Degree, Smooth S80-80 Degree, Smooth	NA-No Accessory CL-Clear Lens DL-Diffusing Lens HC-Honeycomb Louver SL-Solite Lens	Standard WH-White BK-Black SL-Silver  Premium <sup>1</sup> MA-Mocha CC-Charcoal CR-Cerulean FB-Firebrick	Standard WH-White BK-Black SL-Silver  Premium <sup>1</sup> MA-Mocha CC-Charcoal CR-Cerulean FB-Firebrick

### DRIVER

### DRIVER OPTIONS<sup>2</sup>

PHSD-Forward/Reverse Phase, 1% Dimming, 120V Only  
 010S-0-10V, 1% Dimming, 120/277V  
 0103-0-10V, 1% Dimming, 347V Only  
 010L-EldoLED, 0-10V, Linear, 0.1% Dimming, 120/277V  
 010G-EldoLED, 0-10V, Log, 0.1% Dimming, 120/277V  
 DALI-EldoLED, DALI Protocol 2, DT-6, 0.1% Dimming, 120/277V  
 DALI8-EldoLED, DALI Protocol 2, DT-8, 0.1% Dimming, 120/277V  
 LUTE-Lutron HiLume Ecodigital, 1% Dimming, 120V/277V  
 DMX-EldoLED, DMX, 0.1% Dimming, 120V/277V

NA-None

1 - Premium finishes may have extended lead times. Custom RALs are available, please consult Inside Sales with specific request.

2 - AAWNR/CSMB available upon request, contact Senso for details.

3 - TW2765 only available with 15 lumens and 010L/010G/DALI8/DMX. Always remote mounted. Cannot use with EMG.

CONTACT FACTORY FOR MORE OPTIONS.

# LETO 11.5

SURFACE CONDUIT LED CYLINDER  
TUNABLE WHITE & WARM DIM

## Dimensions

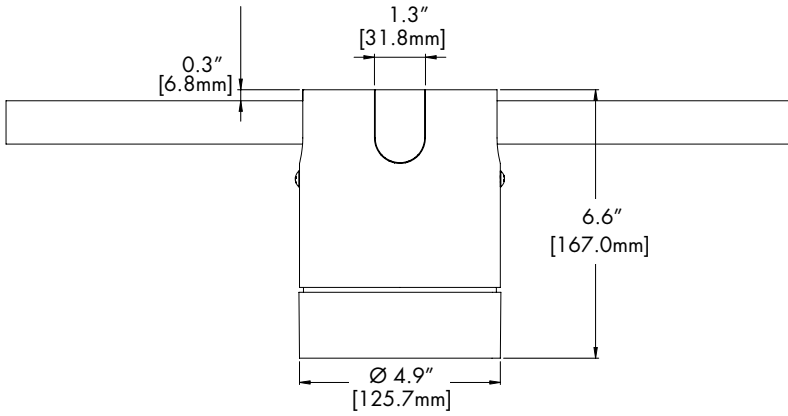

## Lens & Accessory Options

### OPTC-ACC-CL-94MM

Clear Lens

Also available with complete fixture, use ordering code.

-CL



Light Loss Factor: 100%\*

### OPTC-ACC-DL-94MM

Diffusing Lens

Also available with complete fixture, use ordering code.

-DL



Light Loss Factor: 87%\*

### OPTC-ACC-HC-94MM

Honeycomb Lens

Also available with complete fixture, use ordering code.

-HC



Light Loss Factor: 45%\*

### OPTC-ACC-SL-94MM

Solite Lens

Also available with complete fixture, use ordering code.

-SL



Light Loss Factor: 92%\*

\*Light Loss Factor calculated with 60° faceted reflector.

## Optics

### RFLC-FXX-94MM

Faceted Reflector

Also available with complete fixture, use ordering code.

-F10/-F18/-F30/-F45/-F60



### RFLC-SXX-94MM

Smooth Reflector

Also available with complete fixture, use ordering code.

-S30/-S45/-S60



FXX	Optic
F10	10° Faceted
F18	18° Faceted
F30	30° Faceted
F45	45° Faceted
F60	60° Faceted
S30	30° Smooth
S45	45° Smooth
S60	60° Smooth

# LETO 11.5

SURFACE CONDUIT LED CYLINDER  
TUNABLE WHITE & WARM DIM

## Remote Driver Housing

Depending on the options selected in the order code on page 1, a Remote Driver Housing may be required. This will automatically be generated and put on your order as necessary.

REMOTE DRIVER	MODEL	OUTPUT	CCT	DRIVER	DRIVER OPTIONS
HRM-Housing, Remote	LET115-SC-Leto 11.5 Surface Conduit	Same as Fixture	Same as Fixture	Same as Fixture	Same as Fixture

Maximum mounting distance to luminaire using 18 AWG wire						
010S	PHSD	010L	010G	DALI DALI8	DMX	LUTE
16'	16'	72'	72'	72'	149'	15'

### HRM Single with Externally Mounted Driver

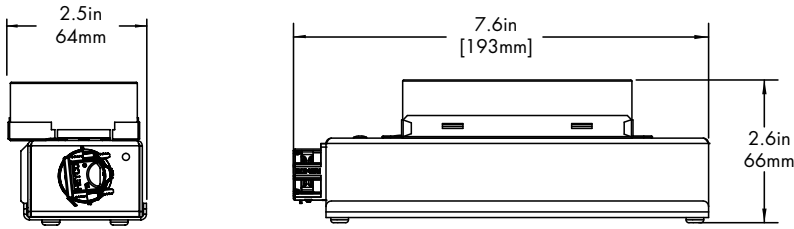

Driver
010L or 010G
010S
010L or 010G or 010S
DALI or LUTE

### HRM Single

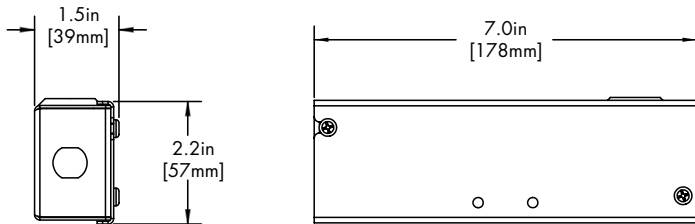

Driver
PHSD

### HRM Double

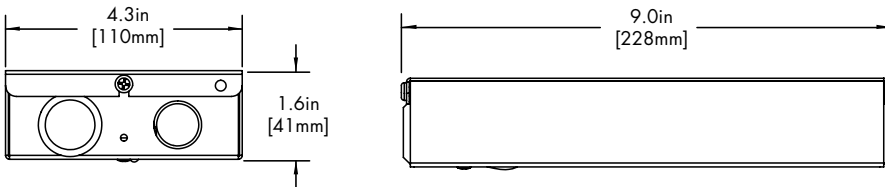

Driver
DALI8
DMX

### EMG Emergency Driver

120 minute EMG operation time.

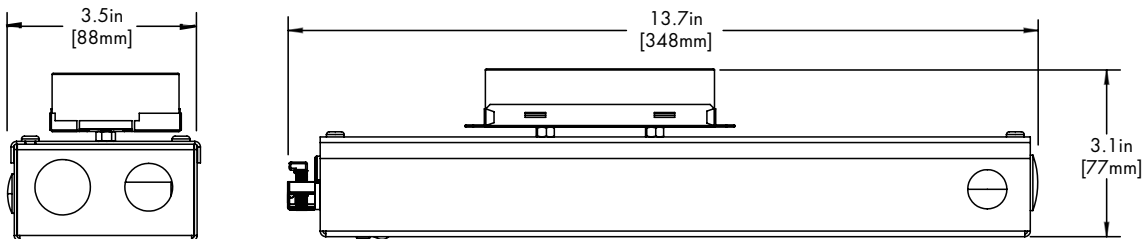

Driver
EMG

# LETO 11.5

SURFACE CONDUIT LED CYLINDER  
TUNABLE WHITE & WARM DIM

## Standard Finishes

**BK**  
Black



**WH**  
White



**SL**  
Silver



## Premium Finishes

**MA**  
Mocha



**CC**  
Charcoal



**CR**  
Cerulean

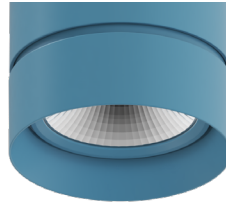

**FB**  
Firebrick

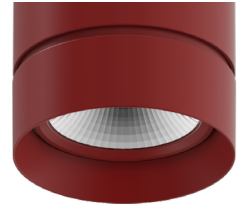

## Two Tone Baffle

Inside finish refers to Baffle Finish selection from page 1. Any combination may be used for baffle and body finishes.

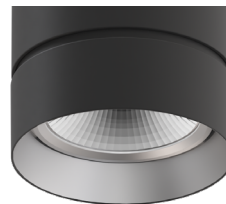
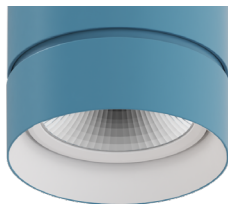
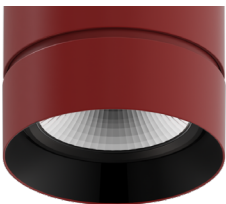

# LETO 11.5

SURFACE CONDUIT LED CYLINDER  
TUNABLE WHITE & WARM DIM

## TM-30

Warm Dim 1800K

COLOR VECTOR GRAPHIC

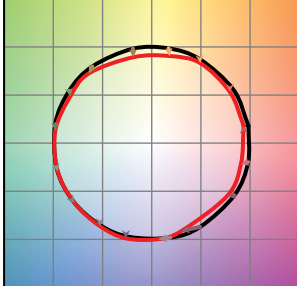

— Reference Source — Test Source

Warm Dim 3000K

COLOR VECTOR GRAPHIC

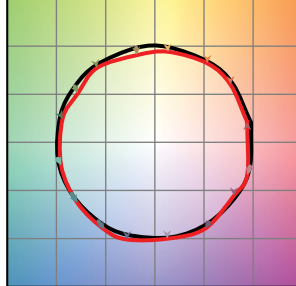

— Reference Source — Test Source

Tunable White 2700K

COLOR VECTOR GRAPHIC

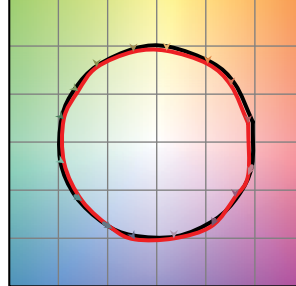

— Reference Source — Test Source

Tunable White 6500K

COLOR VECTOR GRAPHIC

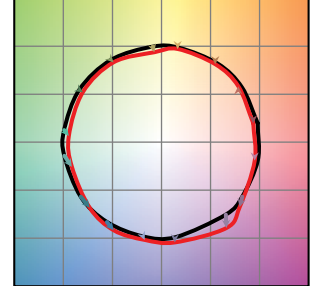

— Reference Source — Test Source

## Photometry

### 10° Faceted Reflector

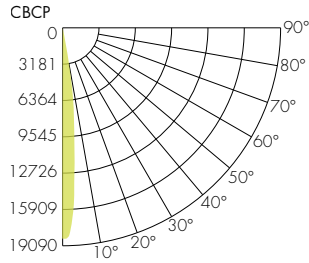
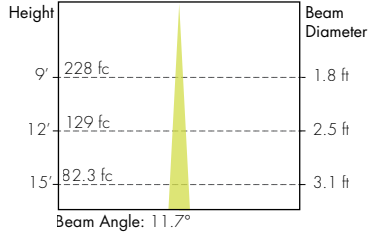

### 30° Smooth Reflector

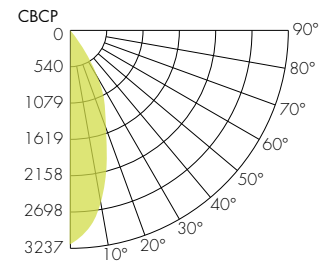
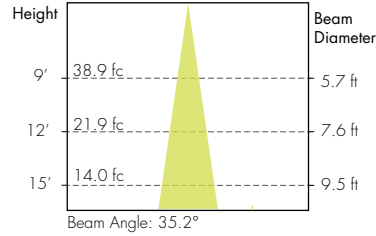

### 18° Faceted Reflector

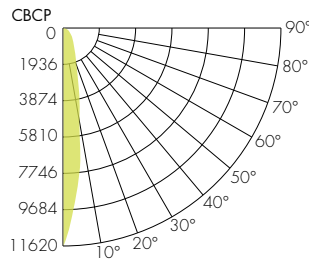
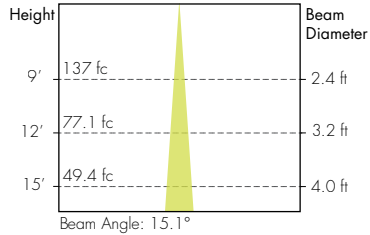

### 45° Smooth Reflector

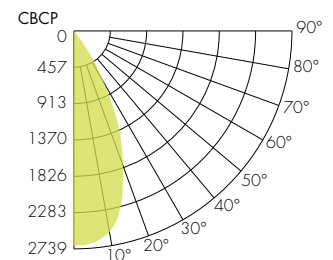
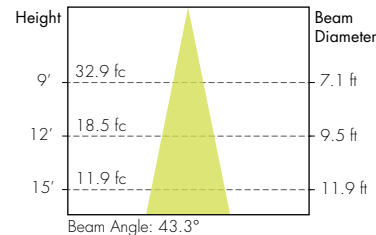

### 30° Faceted Reflector

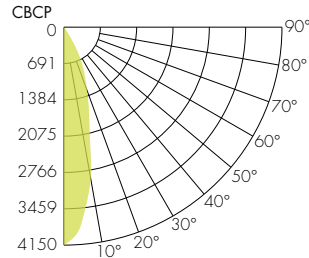
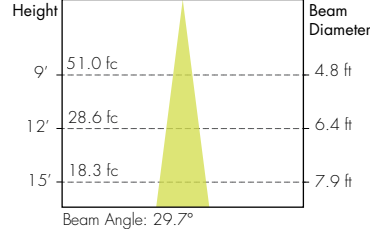

### 80° Smooth Reflector

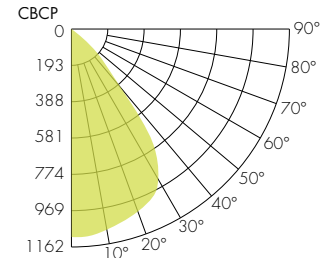
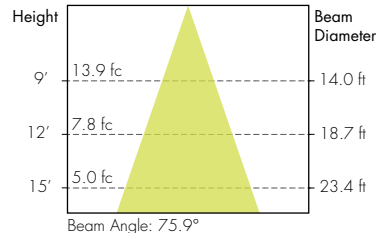

### 45° Faceted Reflector

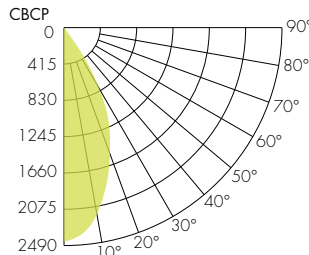
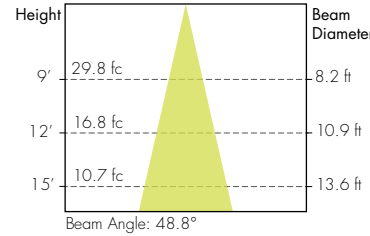

### 60° Faceted Reflector

