

LETO 44 P MID

PENDANT LED DOWNLIGHT



Leto 44 P MID - Pendant LED Downlight. Middle size of the Leto 44 Family, the Leto 44 P MID is anything but mediocre. Perfect proportions give this fixture adaptability and easy configuration.

Ordering Code

Fixture	701							
	1	2	3	4	5	6	7	8
Driver							--	--
	1	2	3	4	5	6	7	8

Product Specifications

SAMPLE: Fixture **701 - A90 - 615 - 27 - 07 - DL - 08 - 01** | Driver **952 - 08 - 02 - 01 - STD - 120 - A90 - 07**

1 - Model	2 - LED	3 - Optic	4 - CCT	5 - Lumen	6 - Accessory
701 · Leto 44 Medium Pendant	A90 · Accuracy	615 · 15° 630 · 30° 645 · 45° 660 · 60°	25 · 2500K 27 · 2700K 30 · 3000K 35 · 3500K 40 · 4000K 65 · 6500K	07 · 700 (6.5W) 10 · 1000 (9.3W) 15 · 1500 (12.5W) 20 · 2000 (20.2W)	00 · No Accessory DL · Diffusing Lens HO · Honeycomb SL · Solite Lens

7 - Body Color		8 - Baffle Color		1 - Canopy Style	2 - Canopy Color		3 - Suspension (6' incl.)
<i>Standard</i>	<i>Premium</i>	<i>Standard</i>	<i>Premium</i>	956 · Square	<i>Standard</i>	<i>Premium</i>	02 · 2 Aircraft + Feed Cable 03 · Solid Stem (6' MAX) 04 · Hang Straight Solid Stem 05 · 2 Powered Aircraft ^{*1} <i>Contact Senso for specific length</i>
01 · White 02 · Black 08 · Silver	52 · Mocha 53 · Charcoal 54 · Cerulean 55 · Firebrick XX · RAL	01 · White 02 · Black 08 · Silver	52 · Mocha 53 · Charcoal 54 · Cerulean 55 · Firebrick XX · RAL		01 · White 02 · Black 08 · Silver	52 · Mocha 53 · Charcoal 54 · Cerulean 55 · Firebrick XX · RAL	

4 - Feed Cable	5 - Driver		6 - Voltage		7 - LED	8 - Lumen
		Dim Level		Dim Level		
00 · None ^{*1} 01 · White 02 · Black 03 · Clear XX · Custom	STD · Non Dimming LCS · 0 - 10 Volt Protocol DIM · Phase ^{*2} ELDOLC · EldoLED 0 - 10 Volt DALI · DALI Protocol LUTES · Hilume Ecodigital	N/A 1% 1% 0.1% 0.1% 1%	LUT2W · 2 Wire for phase ^{*2} LUT5S · 5 Series Eco System DMX · Senso ^{*3} EMG · Emergency Driver ^{*3/4} CSMB · Casambi Wireless Control ^{*3/4}	1% 5%	120 · 120V 277 · 277V 347 · 347V ^{*5}	Same as Fixture Same as Fixture

*1 no feed cable color option for **05** - 2 Powered Aircraft

*2 120V only

*3 remote mount

*4 second driver required

*5 not available with ELDO, Lutron or DMX

LETO 44 P MID

PENDANT LED DOWNLIGHT

Canopy

Square Canopy

2 Aircraft Cable
w/ Feed Cable

2 Powered
Aircraft Cable

Solid Stem

Hang Straight
Solid Stem



Suspension

2 Aircraft Cable
w/ Feed Cable

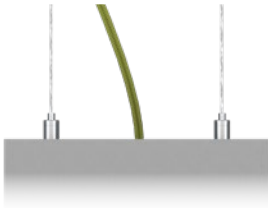

Solid Stem

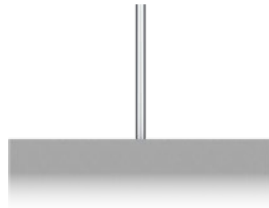

2 Powered Aircraft

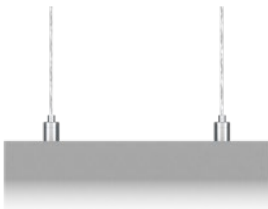

Installation

- The included canopy fits on a standard junction box
- Height adjustable aircraft cable, feed cable or solid stem suspension (specify height) included
- Electrical feed cable included

Construction / Finish

- High quality, scratch resistant powder coated finish in standard, premium or custom colors
- Aluminum extruded Body
- Made in Canada

Dimensions

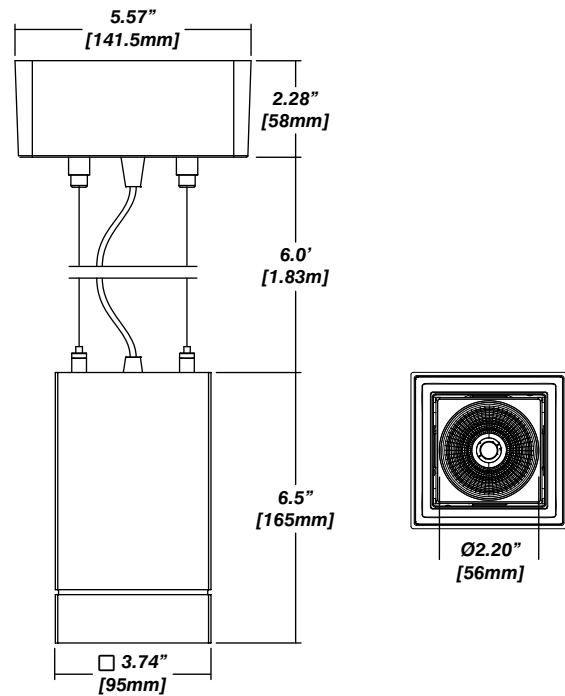

Accessories

Diffusing Lens



Honeycomb Mesh



Solite Lens

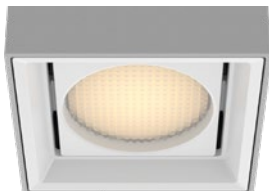

Reflector

Senso metal spun faceted reflectors are specifically designed to retain as much light as possible. This results in a more power efficient fixture with a higher delivered lumen.

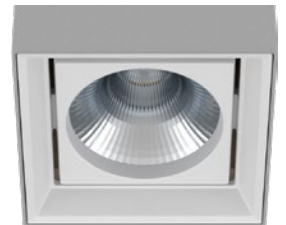

LETO 44 P MID

PENDANT LED DOWNLIGHT



Photometrics

Senso's in-house photometric testing ensures that our lighting design can match your needs precisely. Our Goniophotometer and testing lab produces on-demand photometry files based on any specified fixture, including LM-79 Test reports, IES Files, and CRI/CCT measurements. See Sensolighting.com for more information.

**Full photometric Reports and IES files available for every configuration*

Leto 44 Light Distribution

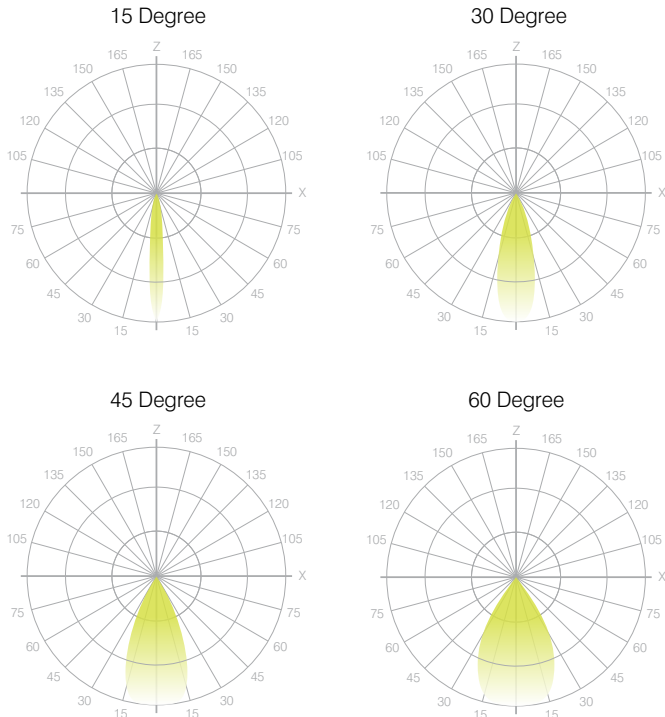

Color Metrics

TM 30-15

Our clients deserve the best information possible about their lighting choices. That's why Senso has invested in the Illuminating Engineering Society (IES) TM 30-15, a new system that measures an LED light source's color rendering properties. Using Senso's state-of-the-art goniophotometer, this method identifies the optimal light source for your project and helps evaluate the trade-offs between efficacy and color rendering. Senso can provide TM 30-15 data for all of our products.

**Full Color Metric Info Available at Sensolighting.com*

LED Module Performance

- Output:** Up to 150 lumen/Watt
- Efficacy:** Color consistency within a 3-MacAdam Ellipse
- CCT:** 2500K - 6500K
- Color Rendering:** 90+ CRI
- Min. R Values:** R⁹ - 60 R^f - 90 R^a - 100

Driver and Power Consumption

- Dimming:** 1% dimming standard with 0.1% option
Casambi wireless control available
- Ripple:** Industry leading Low ripple
- Efficiency:** Power Factor >0.9
Efficiency over 85%
Class 2 output for safety
- Installation:** Canopy or remote mounted

Lumen Option	700lm	1000lm	1500lm	2000lm
Fixture Wattage	6.5W	9.3W	12.5W	20.2W
Delivered Lumen	656lm	1035lm	1347lm	1917lm