

LETO 44 S MID

SURFACE MOUNT LED DOWNLIGHT



Leto 44 S MID - Surface LED Light. Middle size of the Leto 44 Family, the Leto 44 S MID is anything but mediocre. Perfect proportions give this fixture adaptability and easy configuration. Leto 44 S MID will **NOT** fit over a standard junction box. Requires client supplied reducer ring (TNB 54 C 3) for installation.

Ordering Code

Fixture	704							
	1	2	3	4	5	6	7	8
Driver				--	--			
	1	2	3	4	5			

Product Specifications

SAMPLE: Fixture **704 - A90 - 615 - 27 - 07 - HO - 08 - 01** | Driver **910 - STD - 120 - A90 - 07**

1 - Model	2 - LED	3 - Optic	4 - CCT	5 - Lumen	6 - Accessory	7 - Body Color
704 · Leto 44 Medium Surface Mount	A90 · Accuracy	615 · 15° 630 · 30° 645 · 45° 660 · 60°	25 · 2500K 27 · 2700K 30 · 3000K 35 · 3500K 40 · 4000K 65 · 6500K	07 · 700 (6.5W) 10 · 1000 (9.3W) 15 · 1500 (12.5W)	00 · No Accessory DL · Diffusing Lens HO · Honeycomb SL · Solite Lens	Standard Premium 01 · White 52 · Mocha 02 · Black 53 · Charcoal 08 · Silver 54 · Cerulean 55 · Firebrick XX · RAL

8 - Baffle Color	1 - Housing	2 - Driver	Dim Level	Dim Level
Standard Premium 01 · White 52 · Mocha 02 · Black 53 · Charcoal 08 · Silver 54 · Cerulean 55 · Firebrick XX · RAL	00 · Integral Driver 910 · Remote Driver Housing	STD · Non Dimming LCS · 0 - 10 Volt Protocol DIM · Phase ^{1/2} ELDOLC · EldoLED 0 - 10 Volt ^{*2} DALI · Dali Protocol ^{*2} LUTES · Hilume Ecodigital ^{*2}	N/A 1% 1% 0.1% 0.1% 1%	LUT2W · 2 Wire for phase ^{*1/2} 1% LUT5S · 5 Series Eco System ^{*2} 5% DMX · SENSO ^{*2} EMG · Emergency Driver ^{*2/3} CSMB · Casambi Wireless Control ^{*2/3}

3 - Voltage	4 - LED	5 - Lumen
120 · 120V 277 · 277V 347 · 347V ^{*4}	Same as Fixture	Same as Fixture

*1 120V only
*2 remote mount
*3 second driver required
*4 not available with ELDO, Lutron or DMX

LETO 44 S MID

SURFACE MOUNT LED DOWNLIGHT

Reflector

SENSO metal spun faceted reflectors are specifically designed to retain as much light as possible. This results in a more power efficient fixture with a higher delivered lumen.

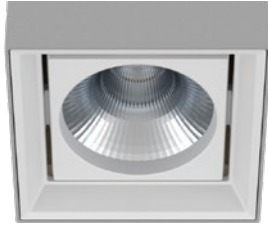

Accessories

Diffusing Lens

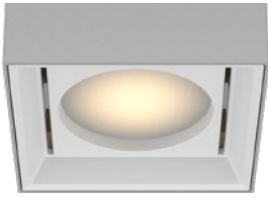

Honeycomb Mesh

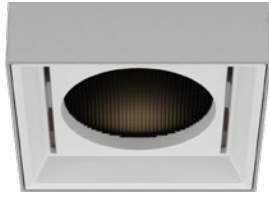

Solite Lens

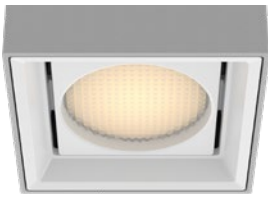

Installation

- Mounting plate included
- Easy, single motion installation method
- Requires client supplied reducer ring (TNB 54 C 3)

Construction / Finish

- High quality, scratch resistant powder coated finish in standard, premium or custom colors
- Aluminum extruded Body
- Made in Canada

Dimensions

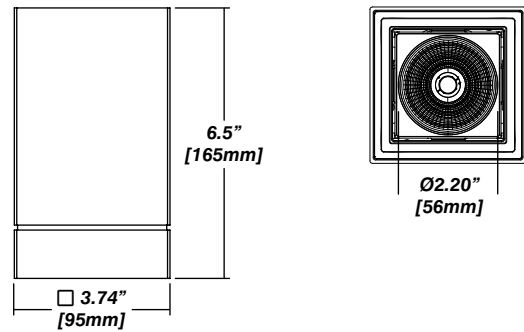

Senso Driver Housings

Single Remote Driver Housing

- Fits Standard, LCS or DIM drivers
- Galvanized steel enclosure
- For remote driver applications

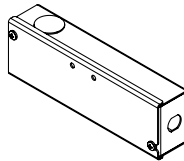

Dimensions

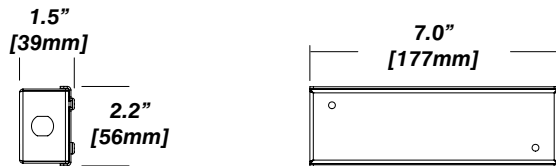

Double Remote Driver Housing

- Fits all drivers
- Galvanized steel enclosure
- For remote driver applications

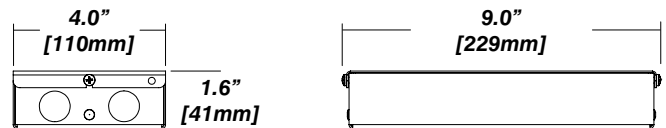
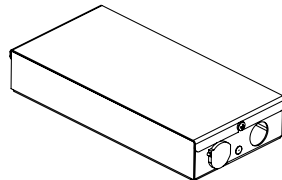

LETO 44 S MID

SURFACE MOUNT LED DOWNLIGHT



Photometrics

SENSO's in-house photometric testing ensures that our lighting design can match your needs precisely. Our Goniophotometer and testing lab produces on-demand photometry files based on any specified fixture, including LM-79 Test reports, IES Files, and CRI/CCT measurements. See SENSOlighting.com for more information.

**Full photometric Reports and IES files available for every configuration*

Leto 44 Light Distribution

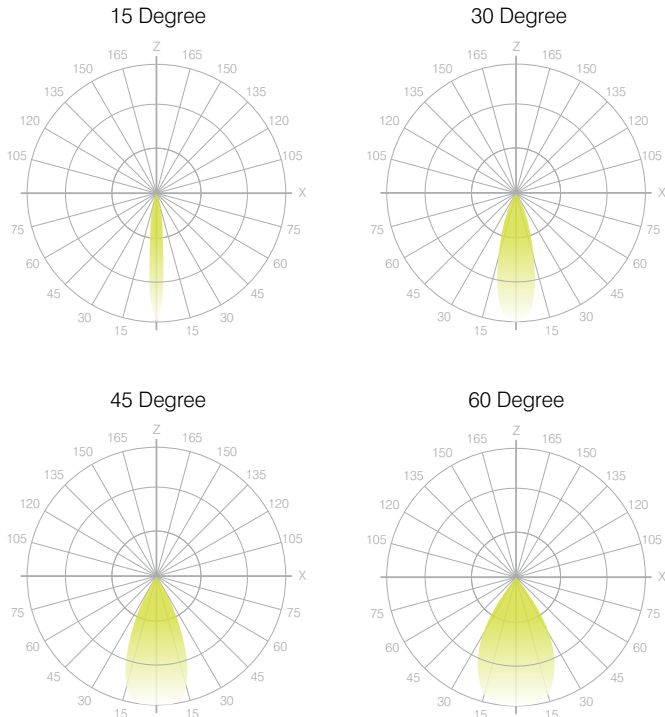

Color Metrics

TM 30-15

Our clients deserve the best information possible about their lighting choices. That's why SENSO has invested in the Illuminating Engineering Society (IES) TM 30-15, a new system that measures an LED light source's color rendering properties. Using SENSO's state-of-the-art goniophotometer, this method identifies the optimal light source for your project and helps evaluate the trade-offs between efficacy and color rendering. SENSO can provide TM 30-15 data for all of our products.

**Full Color Metric Info Available at SENSOlighting.com*

LED Module Performance

Dimming: 1% dimming standard with 0.1% option
Casambi wireless control available

Ripple: Industry leading Low ripple

Efficiency: Power Factor >0.9
Efficiency over 85%

Class 2 output for safety

Installation: Canopy or remote mounted

Driver and Power Consumption

Dimming: 1% dimming standard with 0.1% option

Ripple: Industry leading Low ripple

Efficiency: Power Factor >0.9
Efficiency over 85%

Class 2 output for safety

Installation: Canopy or remote mounted

Lumen Option	700lm	1000lm	1500lm
Fixture Wattage	6.5W	9.3W	12.5W
Delivered Lumen	656lm	1035lm	1347lm