

LETO 44 WM A LRG

ASYMMETRIC WALL MOUNT LED DOWNLIGHT

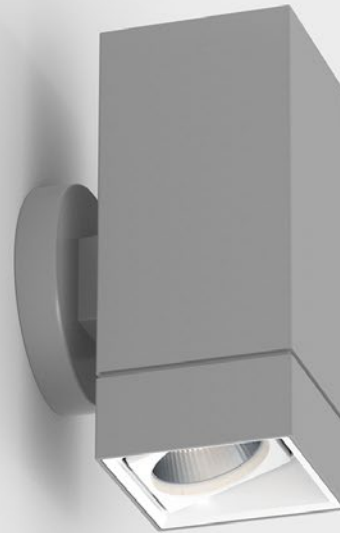

Leto 44 WM A LRG - Wall Mount asymmetric LED Downlight. Leto 44 WM A LRG is a wall mounted square LED fixture that casts light away from the wall filling your space with more functional indirect light.

Ordering Code

Fixture	719A		--					
	1	2	3	4	5	6	7	8
Driver				--	--			
	1	2	3	4	5			

Product Specifications

SAMPLE: Fixture **719A - A90 - 615 - 27 - 07 - DL - 08 - 02** | Driver **910 - STD - 120 - A90 - 07**

1 - Model	2 - LED	3 - Optic	4 - CCT	5 - Lumen	6 - Accessory	7 - Body Color
719A · Leto 44 Large Asymmetric Wall Mount	A90 · Accuracy	<i>Leto 44 A is equipped with a fixed beam spread. For other optics please contact SENSO.</i>	25 · 2500K 27 · 2700K 30 · 3000K 35 · 3500K 40 · 4000K 65 · 6500K	07 · 700 (6.5W) 10 · 1000 (9.3W) 15 · 1500 (12.5W)	DL · Diffusing Lens	Standard Premium 01 · White 52 · Mocha 02 · Black 53 · Charcoal 08 · Silver 54 · Cerulean 55 · Firebrick XX · RAL

8 - Baffle Color	1 - Housing	2 - Driver	Dim Level	Dim Level
Standard Premium 01 · White 52 · Mocha 02 · Black 53 · Charcoal 08 · Silver 54 · Cerulean 55 · Firebrick XX · RAL	00 · Integral Driver 910 · Remote Driver Housing	STD · Non Dimming LCS · 0 - 10 Volt Protocol DIM · Phase ^{*1} ELDOLC · EldoLED 0 - 10 Volt ^{*2} DALI · Dali Protocol ^{*2} LUTES · Hilume Ecodigital ^{*2}	N/A 1% 1% 0.1% 0.1% 1%	LUT2W · 2 Wire for phase ^{*1/2} 1% LUT5S · 5 Series Eco System ^{*2} 5% DMX · Senso ^{*2} EMG · Emergency Driver ^{*2/3} CSMB · Casambi Wireless Control ^{*2/3}

3 - Voltage	4 - LED	5 - Lumen
120 · 120V 277 · 277V 347 · 347V ^{*4}	Same as Fixture	Same as Fixture

*1 120V only
*2 remote mount
*3 second driver required
*4 not available with ELDO, Lutron or DMX

LETO 44 WM A LRG

ASYMMETRIC WALL MOUNT LED DOWNLIGHT



Reflector

Faceted Reflector

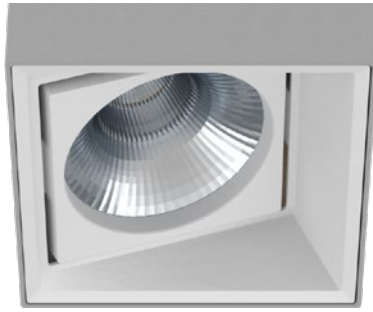

SENSO metal spun faceted reflectors are specifically designed to retain as much light as possible. This results in a more power efficient fixture with a higher delivered lumen.

Accessories

Diffusing Lens

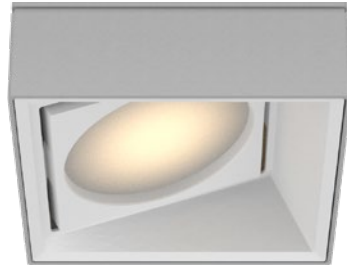

Installation

- Mounting plate included
- Easy, single motion installation method

Construction / Finish

- High quality, scratch resistant powder coated finish in standard, premium or custom colors
- Aluminum extruded Body
- Made in Canada

Dimensions

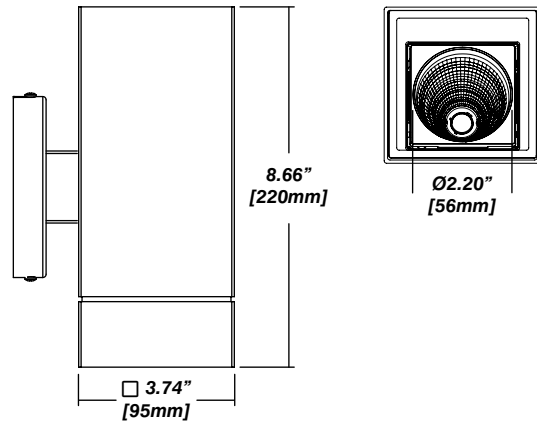

Senso Driver Housings

Single Remote Driver Housing

- Fits Standard, LCS or DIM drivers
- Galvanized steel enclosure
- For remote driver applications

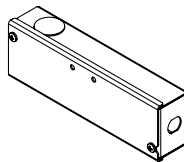

Dimensions

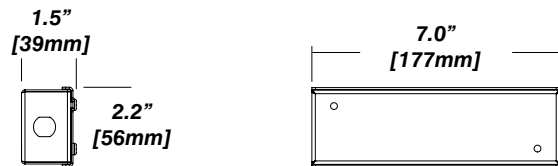

Double Remote Driver Housing

- Fits all drivers
- Galvanized steel enclosure
- For remote driver applications

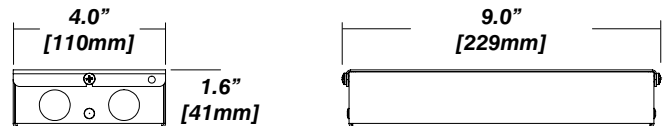
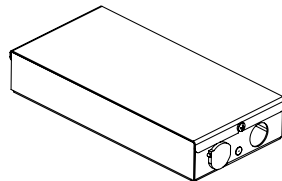

LETO 44 WM A LRG

ASYMMETRIC WALL MOUNT LED DOWNLIGHT



Photometrics

Senso's in-house photometric testing ensures that our lighting design can match your needs precisely. Our Goniophotometer and testing lab produces on-demand photometry files based on any specified fixture, including LM-79 Test reports, IES Files, and CRI/CCT measurements. See Sensolighting.com for more information.

**Full photometric Reports and IES files available for every configuration*

Color Metrics

TM 30-15

Our clients deserve the best information possible about their lighting choices. That's why Senso has invested in the Illuminating Engineering Society (IES) TM 30-15, a new system that measures an LED light source's color rendering properties. Using Senso's state-of-the-art goniophotometer, this method identifies the optimal light source for your project and helps evaluate the trade-offs between efficacy and color rendering. Senso can provide TM 30-15 data for all of our products.

**Full Color Metric Info Available at sensolighting.com*

LED Module Performance

Output: Up to 150 lumen/Watt

Efficacy: Color consistency within a 3-MacAdam Ellipse

CCT: 2500K - 6500K

Color Rendering: 90+ CRI

Min. R Values: R⁹ - 60 R^f - 90 R^a - 100

Driver and Power Consumption

Dimming: 1% dimming standard with 0.1% option
Casambi wireless control available

Ripple: Industry leading Low ripple

Efficiency: Power Factor >0.9

Efficiency over 85%

Class 2 output for safety

Installation: Remote mounted

Lumen Option	700lm	1000lm	1500lm
Fixture Wattage	6.5W	9.3W	12.5W
Delivered Lumen	656lm	1035lm	1347lm