



Stiletto - Trimless recessed linear LED system. The Stiletto is a trimless-recessed linear profile for drywall ceilings. It is designed for a seamless and continuous look that is available for straight runs as well as complex shapes. Additionally, the Stiletto features "No-Dots" meaning pixelation is completely eliminated creating a smooth and even lit-up effect.

Ordering Code

Fixture	565	115						
	1	2	3	4	5	6	7	8
Driver		24						
	1	2	3	4	5			

Product Specifications

SAMPLE : Fixture **565 - 115 - 500 - 030 - 27 - B36 - 6'** | Driver **902 - 24 - 025 - STD - 120**

1 - Type	2 - Model	3 - Lens	4 - LED Style ^{*1/3}				
565 · Profile	115 · Stiletto	500 · Frosted	Eco	Pro 56	Pro 112	Controlled White ^{*2}	RGB ^{*2}
		502 · Clear	030 · 110	062 · 194	122 · 383	CT1 · 1059	RGB · RGB
		512 · Black	060 · 207	117 · 376	175 · 559		RGBW · RGB+W
			095 · 329	167 · 540	221 · 742		
			120 · 433	219 · 706	271 · 910	382 · 1235	

5 - CCT	6 - Finish		7 - Feed Point	8 - Fixture Length ^{*3}
Eco	Pro 80 CRI	Pro 90 CRI	Controlled White ^{*2}	RGB ^{*2}
27 · 2700K	22 · 2200K	27 · 2700K	CT1 · 2000 - 5700K	98 · RGB
32 · 3200K	25 · 2500K	30 · 3000K		99 · RGB+W
41 · 4100K		35 · 3500K		
		40 · 4000K		
		50 · 5000K		

1 - Driver	2 - Output Voltage	3 - Wattage	4 - Control	Dim Level	5 - Input Voltage
902 · Standard Driver	24 · 24V	025 · 25W ^{*4}	STD · Standard Driver	N/A	120 · 120V
908 · Magnetic Low-Voltage		040 · 40W	DIM · Magnetic Driver ^{*5}	1%	277 · 277V
		060 · 60W	LCS · 0 - 10 Volt Protocol	1%	347 · 347V ^{*7}
		096 · 96W	DALI · Dali Protocol ^{*6}	0.1%	
			DMX · SENSO	1%	
			LUTRON · Lutron CV ^{*6}	0.1%	

*1 Measured in Lm/ft

*2 DMX driver required

*3 Refer to page 2 for LED cut length intervals

*4 Not available with 908 Driver

*5 Only available with 908 driver and 120V

*6 Only available in 96W

*7 Not available in DALI, LUTRON or DMX

24V Linear LED Light Source

	STYLE	WATT/FT	LUMENS/FT	CRI	MAX. LENGTH	CUT LENGTH	LED/FT	Color TEMPERATURE	DESCRIPTION
ECO	030	1.46	110	83	16.4'	3.94"	18	2700K, 3200K, 4100K	Versatile strip with 3 LED densities, 3 color temperatures and a CRI of 83
	060	2.93	207	83	16.4'	1.97"	36		
	095	4.39	329	83	16.4'	3.94"	18		
	120	5.85	433	83	16.4'	0.98"	73		
PRO 56	062	1.5	194	80/90	32.8'	4.92"	17	80 CRI 2200K, 2500K	Even LED layout (56 led/m - 17 led/ft) for balanced performance and efficiency
	117	2.9	376	80/90	16.4'	4.92"	17		
	167	4.4	540	80/90	13.1'	4.92"	17		
	219	5.9	706	80/90	9.84'	4.92"	17		
PRO 112	122	2.9	383	80/90	23.0'	2.46"	34	90 CRI 2700K, 3000K, 3500K, 4000K, 5000K	Dense LED layout (112 led/m - 34 led/ft) creates no dots with frosted lens
	175	4.4	559	80/90	14.75'	2.46"	34		
	221	5.9	742	80/90	11.5'	2.46"	34		
	271	7.3	910	80/90	9.8'	2.46"	34		
	382	10.2	1235	80/90	6.55'	2.46"	34		
Controlled White	CT1	10.67	1059	85	14.75'	3.54"	40	2000K - 5700K	Color Tunable led strip with a warm/cool range from 2000K to 5700K
RGB	RGB	4.39	204	-	16.4'	3.94"	18	-	Individually control Red, Green, Blue and White (white only with RGB+W)
	RGB+W	6.78	364	-	10.7'	3.54"	81		

* Lumen output based on 3000K / 90CRI. For other output information, please consult SENSO.

Key LED Strip Features

- 3 STEP MacAdam LEDs or Single Bin LEDs
- Stabilized current design
- LED strip efficacy up to 171 lm/W
- Only 8 mm width
- 24V DC voltage input
- Reverse voltage protection
- Thermal conductive adhesive on back side for better heat conduction
- 50,000 hour life expectancy

Lens/Light Distribution

part number **500** (frosted 65% transparent)
502 (clear 95% transparent)

- PMMA construction
- Easily clipped in profile
- Comes precut to match profile length
- Flush

Clear Lens

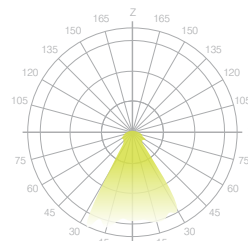

Frosted Lens

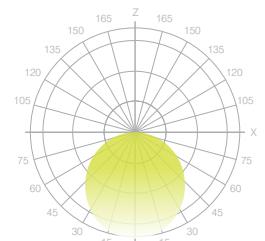

Construction

- Housing: Aluminum extrusion
- Made in Canada

Installation

- Factory assembled for easy and fast installation
- Electrical wire included

Dimensions

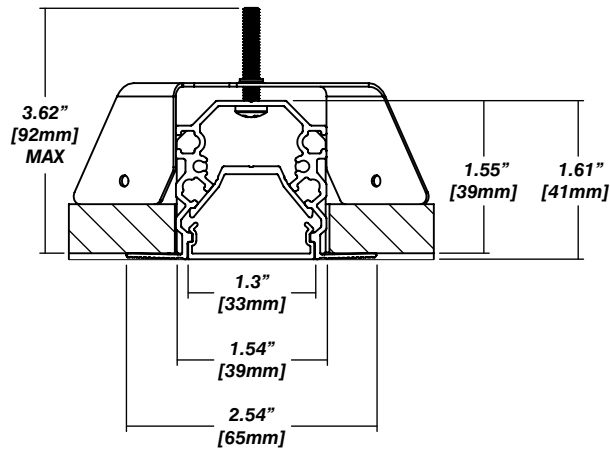

Mounting

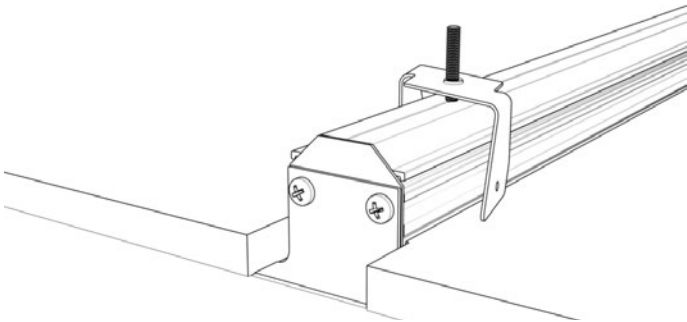

Intersecting System Using Corners, T & X Nodes

The Stiletto system is not limited to straight runs. Available L, T & X nodes, used in association with linear sections, provide freedom to create seamless configurations. For advanced configurations, contact the SENSO factory to complete your system.

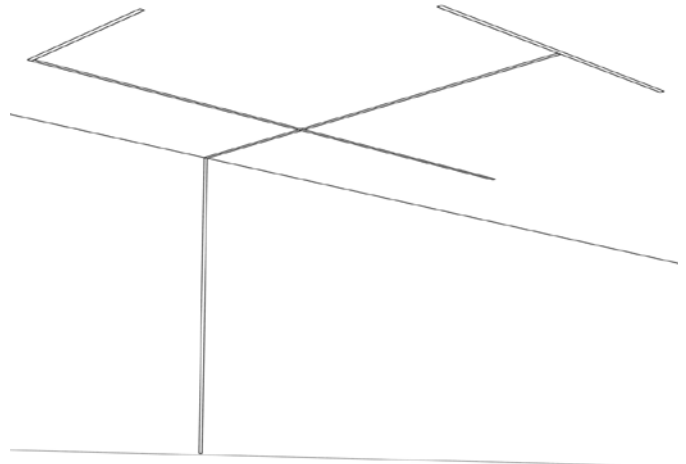

How To Specify

1. Draw your layout, considering:
 - Drawings are made using center axis as reference
 - Indicate preferred feed point location
 - Minimum length per section: 1'
 - Cut length in 2.36" increments
2. Provide the following information
 - Total number of corners
 - Total length
 - Drawing

Notes

Please send us a detailed drawing of your design, making sure to use the centre-line for your dimensions. We will provide you with a complete layout drawing lengths, parts involved, and required feed points.

Drivers for Linear Aluminum Profile

Driver Data

Driver	Output Voltage	Input voltage	Wattage	Efficiency @ Max Load	Power Factor	Dim Level	Dim Protocol			
STD	24V	120V, 277V, 347V	25W - 96W	86%	>0.90	N/A	N/A			
DIM		120V	40W - 96W	>90%	>0.95	1%	Magnetic			
LCS		120V, 277V, 347V	60W - 96W	>87%	>0.95	10%	0-10V			
DALI		120V, 277V	96W			>0.94	0.1%	DALI		
DMX		120V, 277V	25W - 96W				1%	DMX		
LUTRON		120V, 277V	96W				90%	>0.99	0.1%	ECO System

Features

- CSA Approved
- Class 2, Class P
- Auto-reset protection for short circuit and over-temperature
- Overload protection

STD / DMX

DMX requires decoder

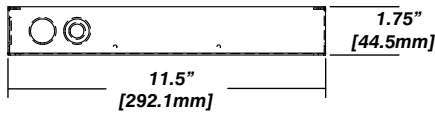
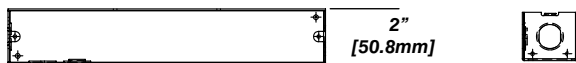

LCS

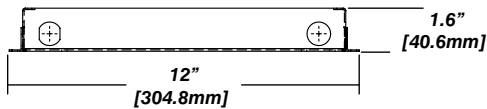
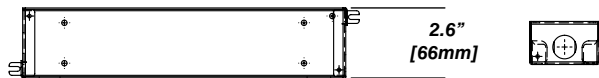

347V

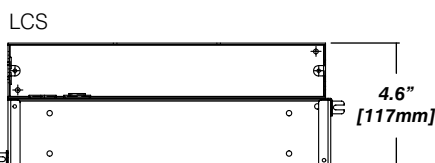

DALI

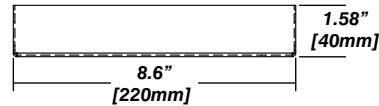
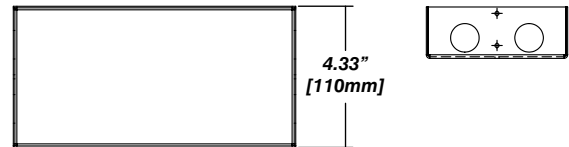

LUTRON

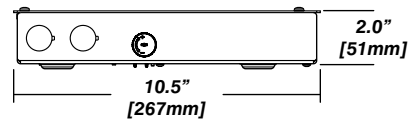
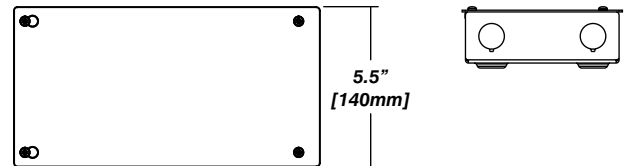

DIM

